

DEVELON

Crawler Excavators

DX350LC-7K



Maximum power	285.6 hp
Operating weight	36.1 t
Bucket capacity	1.83 m ³

DEVELON DX350LC-7K CRAWLER EXCAVATOR:

MEET THE NEW GENERATION OF DEVELON MACHINES

Lift your business to the next level with the DX350LC-7K Develon excavator.

Exceptionally powerful, yet environmentally friendly, the DX350LC-7K excavator features extraordinary fuel efficiency.

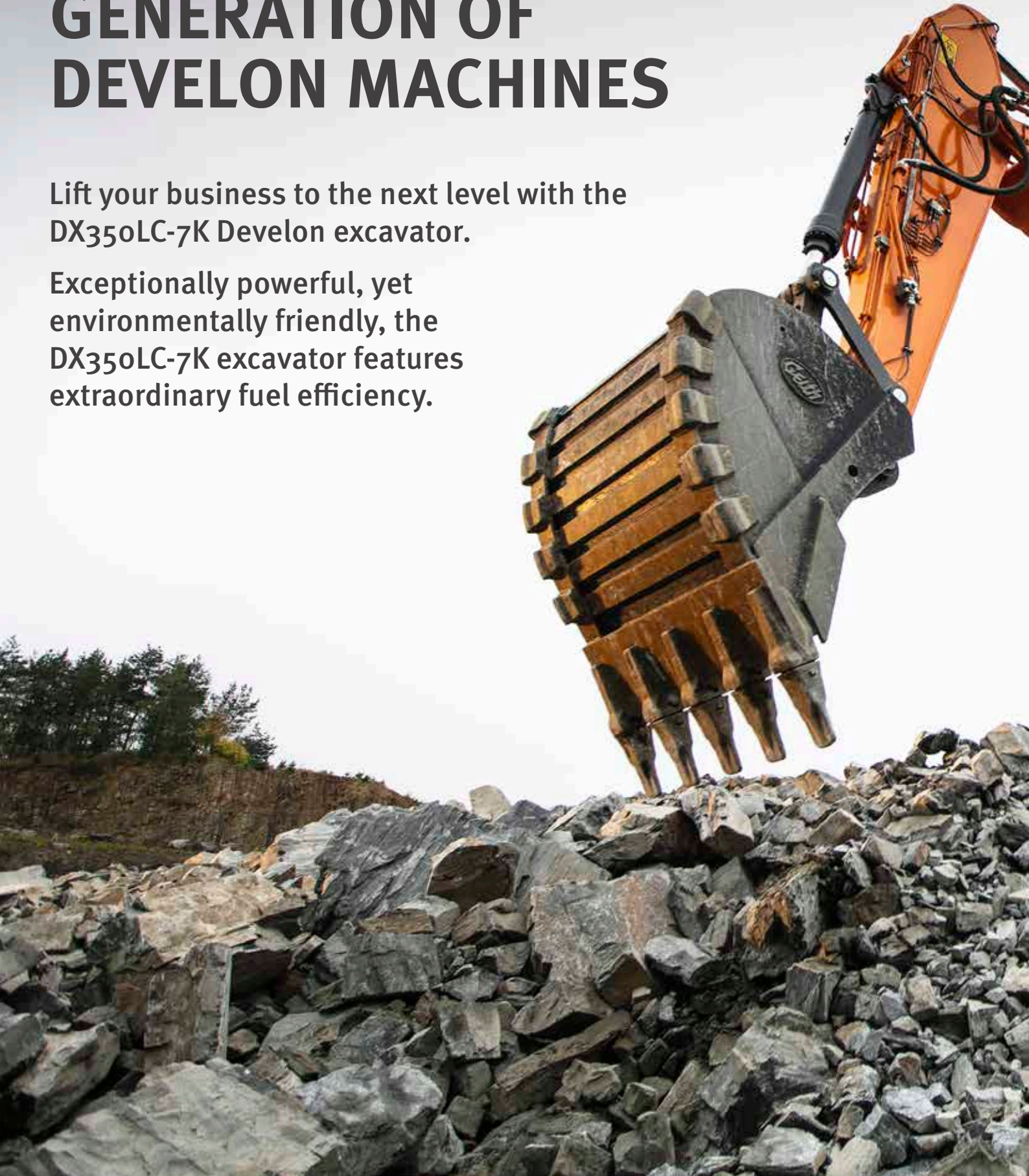



RAISE PROFITS, PRODUCTIVITY & FUEL EFFICIENCY

HIGH PRODUCTIVITY AND LOW COST OF OWNERSHIP

Delivers higher productivity and reduced fuel consumption in an efficient and comfortable work environment.

RELIABILITY

Reinforced castings and forged steel pivot points and reinforced heavy-duty arm and boom to withstand high-impact materials. Monoboom or articulated boom for added versatility. Improved hydraulic line routing to protect your investment.

YOUR SAFETY IS OUR PRIORITY

Anti-slip steps and platforms, as well as guard rails on upper structure are standard equipment.

Our standard 360° all-around view camera (AVM) can be linked with an optional ultrasonic detection for maximum safety while working with people around.

Large side mirrors, 9 powerful LED work lights (4 additional lights possible as an option), travel alarm.

PRODUCTIVITY

State-of-the-art bucket and arm digging forces.

PLUG & PLAY

Machine Guidance options available with major brands' ready kits (Trimble, Leica, Novatron/Moba Xsite, etc.) and can differ by model and region.

UNDERCARRIAGE DURABILITY

Forged steel and deep-hardened top rollers – oil-lubricated rollers – heat-treated sprocket – deep-hardened, heat-treated, grease lubricated & longer life track chains.





UNRIVALLED COMFORT

One of the most spacious cabs in the market, with low noise & vibration levels and excellent all-round visibility. Thanks to the heating and even an optional cooling functionality of the premium seat and improved air ventilation in the DX350LC-7K, you can focus on the job at hand in any situation.

OPERATE AT EASE

New Develon Smart Touch screen, an easy to read and use 8" touch screen integrates all functions and settings of your machine in one place. Don't miss any important call thanks to the hands-free phone system. And forget fumbling with keyholes: unlock the door remotely, and start or stop the engine with the included Develon Smart Key.

ENGINE

Exceptionally powerful – with high torque at low revs – the new Develon engine combines reliability and low environmental impact. This Stage V compliant 6 cylinder engine delivers 213 kW at 1800 rpm.

EXCELLENT FUEL EFFICIENCY

To save fuel, the Smart Power Control (SPC) system optimizes the balance between the pump output and the diesel engine.

EASY MAINTENANCE

Easy access to all compartments. Radiator and oil cooler separated for better cooling and easier access. Maintenance data directly available from control panel.

ADVANCED FILTRATION

Highest efficiency filters & cleaners remove water, dust & particles to protect your investment optimally.



D·ECOPOWER

Real breakthrough technology that will sets new standards in the industry: The exclusive ECO power system improves productivity and saves fuel. A pressure-controlled pump, closed-center main control valve and 9 sensors electronically detect and control the precise amount of hydraulic oil required to perform a task and precisely meter the amount of oil required rather than continuously forcing a fixed amount

of oil through the system, thereby improving efficiency. The hydraulic system output requirements are optimized with engine horsepower. The resulting efficiency sharply improves productivity and reduces fuel consumption. Improved feedback through the controls results in an outstanding level of operator comfort and much smoother machine control.

TOP PERFORMANCE AND FUEL EFFICIENCY

THE POWER TO RAISE PRODUCTIVITY

- The DX350LC-7K is equipped with the latest generation Develon engine
- Stage V compliant, this engine boasts extremely low emissions because reducing our environmental impact is paramount to us
- Exhaust gases are purified by Selective Catalytic Reduction (SCR) technology, a Diesel Oxidation Catalyst (DOC) and a Diesel Particulate Filter (DPF)

EFFICIENT FUEL MANAGEMENT

- Choice of 4 power modes (Eco - Standard - Power - Power Plus) and automatic Smart Power Control system for optimal power and reduced fuel consumption in all conditions
- Smart Power Control (SPC) system: reduces engine speed and adjusts pump torque according to work conditions. The system automatically adjusts engine power and hydraulic output to improve fuel efficiency and reduce emissions
- Engine auto-shut-off: shuts down the engine after the machine has been idling for a specified time. The operator can set the delay before shut-off via the touchscreen

VARIABLE GEOMETRY TURBOCHARGER

Provides optimal air flow to the engine combustion chamber under all speed and load conditions, so that exhaust gas is cleaner and fuel economy is improved.

SPC (SMART POWER CONTROL)

2 systems (Variable Speed Control and Pump Torque Control) work together to improve efficiency while maintaining productivity.





RELIABILITY – THE HABIT OF A LIFETIME

In your profession, you need equipment you can depend on. At Develon, we put durability and reliability at the core of our machines' development. Our materials and structures undergo stringent testing for strength and resilience under the most extreme conditions.

DESIGNED FOR LONG TERM, ALL-ROUND, HEAVY-DUTY PERFORMANCE

EXTRA-STRONG X CHASSIS

Designed using finite element analysis and 3D computer simulation, the X shaped undercarriage ensures optimum structural integrity and durability.

UNDERCARRIAGE DURABILITY

- The chain is composed of sealed, self-lubricating links for long-term dependability. For improved protection, alignment and performance, there are 3 types of guard available: normal, double, and full-length, according to the application
- The track spring and idler are joined for long-lasting performance and easy maintenance
- Cast steel heavy-duty sprockets guarantee the highest resistance
- The track rollers are lubricated for life

STRENGTHENED BOOM AND ARM

During the development of our machines, we use intensive testing to calculate the best load distribution throughout the boom structure.

Combined with thicker material, this means that element fatigue is limited and both reliability and component life are increased. To better protect the base of the arm, reinforced bars have been added and the arm center and end boss have been strengthened.

ADVANCED FILTRATION

- Fuel filters and water separator: a filter-type high-performance water separator effectively captures moisture in the fuel, reducing impurities and helping minimize any fuel-related issues. Pre-filters and dual main filters as standard achieve a high degree of purity that minimises fuel system failures.
- Cyclonic air pre-cleaner: air filter life and engine efficiency are directly related to the amount of debris ingested through the engine's air intake. Therefore, a cyclonic air pre-cleaner (as standard) is the first stage of an air intake system that prevents the majority of heavier-than-air particles from entering. Self-cleaning and maintenance-free, the system is able to expel all types of mixed debris, including mud, snow, rain, leaves, sawdust, chaff, etc.

PIN AND BUSHING ADVANCED TECHNOLOGY

Highly lubricated metal is used for the boom pivot to increase the component's lifetime and lengthen greasing intervals. The bucket pivot features EM (Enhanced Macrosurface) bushings. These have a tailored surface pattern and self-lubricating coating for optimised greasing and more efficient debris removal. Ultra-hard wear-resistant discs and bucket pivot polymer shims increase durability even more.

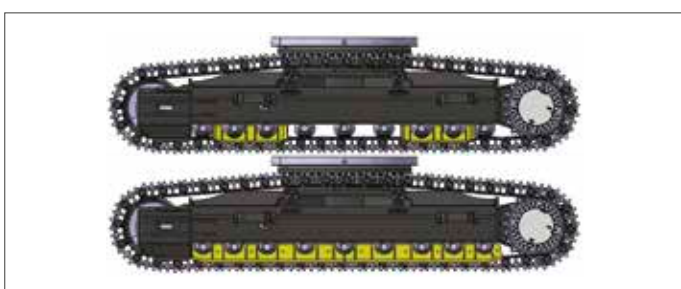

Track guards: to provide better protection, track alignment, and performance of machine while travelling. 2 guards per track as standard (double and full-length track guards available as options). These various track guard options provide you with optimal solutions for your extreme applications.



1

2

3

4

5

6

7

1. Large sun roof
2. Sun visor
3. Window grip
4. Storage compartment for sunglasses
5. Joysticks and switches are integrated in adjustable control consoles
6. Improved visibility on the bottom right
7. Separate seat height adjustment lever and cushion tilting function
8. Straight ergonomic pedals
9. Flat, spacious, easy-to-clean floor

OPERATING IN HIGH COMFORT

BEST-IN-CLASS OPERATOR ENVIRONMENT

The DX350LC-7K is designed to provide you with the best possible working conditions. The sophisticated state-of-the-art ROPS cab is pressurized and ISO-certified for your safety. A high-quality heated seat with air suspension provides maximum operator comfort.

FIRST CLASS COMFORT

Comfortably seated, you benefit from a clear all-round view of the worksite and have easy access to several storage compartments. Noise and vibration levels are remarkably low, while air conditioning and automatic climate control allow you to keep working for hours on end without feeling tired. Pedals, joysticks and armrests have all been designed for operator comfort and efficiency.

CAB SUSPENSION

The cab's suspension system (CabSus mount) dampens vibrations and provides outstanding protection against impact. This system absorbs shocks and vibrations much more effectively than a conventional silentblock suspension system.

KING SIZE TOUCHSCREEN

The wide 8" touchscreen provides easy scrolling through the different menus, including power settings and auxiliary hydraulics settings. It also allows you to connect a Bluetooth device or listen to your favorite radio station.

360° CAMERA SYSTEM

The 360° camera system gives you full view of the machine's surroundings.





1. Proportional switch
2. Display monitor
3. Breaker/Booster button
4. Joystick 1-touch function button
5. Starter switch (Start/Stop button)
6. Engine speed control dial
7. Travel speed selector switch
8. Light switch
9. Cab work light switch
10. After-treatment system switch
11. Bluetooth control panel
12. Air conditioning and heating control panel
13. Wiper control panel
14. Quick coupler switch

TAKE A SEAT IN BUSINESS CLASS

The ergonomic controls and the easy-to-view colour monitor place the machine firmly in your hands.

TOTAL CONTROL IN ALL SIMPLICITY

DYNAMIC POWER MANAGEMENT

- Automatic travel speed range selection (slow/fast)
- Activating the power boost control system increases digging force by 10%
- A one-touch deceleration button immediately reduces engine speed to low idle
- Auto-idling starts 4 seconds (adjustable) after all controls are returned to neutral – reducing fuel consumption and noise levels in the cab

INTELLIGENT FLOATING BOOM MODE (OPTIONAL)

The “intelligent floating boom” function allows the boom to move up and down freely according to the application:

- Hydraulic breaker setting: during boom down operation, the boom moves down freely under its own weight. The result is reduced shock and vibration and longer breaker service life
- Full float setting: during boom down selection, the boom is allowed to rise and fall as required while the bucket is drawn across the ground

4 WORK MODES AND 4 POWER MODES

Delivers the needed power according to your specific application while minimizing fuel consumption:

- 1-way mode, 2-way mode, Digging mode and Lifting mode
- Power Plus mode, Power mode, Standard mode, Economy mode

EXPERT FINGERTIP CONTROL

- The new multi-function 8" touchscreen displays all useful information in a visual and intuitive format.
- At a glance, you can check the machine's status and settings to achieve optimal efficiency.
- Develon's unique jog shuttle switch gives you easy and precise control over all machine functions.
- Highly sensitive and low-effort joysticks enable you to work safely, smoothly and confidently.
- The proportional thumb switches on the joysticks can be mounted horizontally or vertically, as the operator prefers, for optimal control of hydraulic attachments.







SIMPLE MAINTENANCE WITH MAXIMUM UPTIME

MAINTENANCE ACCESS MADE SIMPLE

- Large guard rails are installed along with anti-slip steps and plates, for safer, easier access to the whole upper structure.
- The air conditioning filter is placed on the side of the cab for easy access. The filter's cover can be locked and opened with the starter key.
- A battery cut-off switch makes it easy to disconnect the battery for long-term storage.
- The hour meter display can be easily checked from ground level.
- Shut-off valves have been fitted on the pre-filter piping line and fuel tank drain piping to make servicing easier and prevent pollution from leakage.
- Engine parts can be easily reached via the top and side panels.
- The radiator and oil cooler have been separated, making access for cleaning easier.
- For extra accessibility and servicing convenience, all filters (engine oil filter, fuel pre-filters, fuel filters and pilot filter) are located in the pump compartment.
- An electric transfer pump for initial priming of fuel filters is featured as standard.

ADBLUE® TANK

Connected to the ECU, sensors in the tank detect low levels of AdBlue® or any other system malfunction.

CENTRALISED GREASING POINTS

To make maintenance easier, the greasing points have been centralised. An automatic lubrication system is available as an option.



TECHNICAL SPECIFICATIONS

ENGINE

Designed to deliver superior performance and fuel efficiency, the Develon DLo8V diesel engine fully meets latest stage V emission regulations. To optimise machine performance, the engine uses high-pressure fuel injectors, air-to-air inter-cooler and electronic engine controls. 4-Cycle Water-Cooled, Variable Geometry Turbocharged, Diesel Oxidation Catalyst (DOC) & Selective Catalytic Reduction (SCR) and Diesel Particulate Filter (DPF).

Model

Develon DLo8V

No. of cylinders

6

Rated power at 1800 rpm

SAE J1995 213.0 kW (285.6 hp)
SAE J1349 209.1 kW (280.4 hp)

Max. torque at 1300 rpm

1275 Nm

Idle (low - high)

800 [±10] - 1900 [±25] rpm

Displacement

7640 cm³

Bore × stroke

108 mm × 139 mm

Starter

24 V / 6 kW

Batteries - Alternator

2 × 12 V, 150 Ah - 24 V, 80 A

Air filter

Double element air cleaner and pre-filtered Cyclone Turbo dust separator

UNDERCARRIAGE

Extremely robust construction throughout - made of high-quality, durable materials, with all welded structures designed to limit stresses.

- Track rollers lubricated for life
- Idlers and sprockets fitted with floating seals
- Track shoes made of induction-hardened alloy with triple grouser
- Heat-treated connecting pins
- Hydraulic track adjuster with shock-absorbing tension mechanism

Upper rollers (standard shoe)

2

Lower rollers

9

Number of links & shoes per side

48

Link pitch

216 mm

HYDRAULIC SYSTEM

The e-EPOS (Electronic Power Optimising System) is the brain of the excavator – minimising fuel consumption and optimizing the efficiency of the hydraulic system for all working conditions. To harmonise the operation of the engine and the hydraulics, the e-EPOS is connected to the engine's electronic control unit (ECU) via a data transfer link.

- The hydraulic system enables independent or combined operations
- 2 travel speeds offer either increased torque or high speed
- Cross-sensing pump system for fuel savings
- Auto-deceleration system
- 4 operating modes, 4 power modes
- Flow and pressure control of auxiliary hydraulic circuits from control panel
- Computer-aided pump flow control

Main pumps

2 × variable displacement tandem axial piston pumps
Maximum flow at 1800 rpm 2 × 350 l/min

Pilot pump

Gear pump
Maximum flow at 1800 rpm 24.12 l/min

Relief valve settings

Implement 380 bar (387.5 kgf/cm²)
Travel 343 bar (350 kgf/cm²)
Swing 294 bar (300 kgf/cm²)
Pilot 40 bar (40.8 kgf/cm²)

HYDRAULIC CYLINDERS

High-strength steel piston rods and cylinder bodies. Shock-absorbing mechanism fitted in all cylinders for shock-free operation and extended piston life.

Cylinders	Quantity	Bore × rod diameter × stroke (mm)
Boom	2	150 × 100 × 1450
Arm	1	170 × 120 × 1805
Bucket	1	150 × 100 × 1300
Two-piece boom	1	180 × 110 × 1300

CAB

The air-conditioning and heating systems are integrated for optimal climate control. An automatically-controlled fan supplies the pressurised and filtered cab air, which is distributed throughout the cab from multiple vents.

The heated air suspension, adjustable operator's seat includes a seat belt. The operator can adjust the ergonomic seat and joystick console separately according to his preferences.

A-weighted emission sound pressure level at the operator's position, LpAd (ISO 6396:2008)

70 dB(A)

A-weighted sound power level, LwAd (2000/14/EC)

Declared: 105 dB(A)

Measured: 104 dB(A)

SWING MECHANISM

The swing mechanism uses an axial piston motor, driving a 2-stage planetary reduction gear bathed in oil for maximum torque.

- Swing bearing: single-row, shear type ball bearing with induction hardened internal gear
- Internal gear and pinion immersed in lubricant

Maximum swing speed

9.90 rpm

Maximum swing torque

14830 kgf·m

FLUID CAPACITIES

Fuel tank	600 l
Cooling system (radiator)	56 l
Urea (def) tank	63 l
Hydraulic oil tank	380 l
Engine oil	42 l
Swing drive	8 l
Travel device	2 × 7 l

DRIVE

Each track is driven by an independent, high-torque axial piston motor through a planetary reduction gearbox. Two levers / foot pedals guarantee smooth travel with counter-rotation on demand. The track frame protects the travel motor, brake and planetary gears. The multi-disc track brakes are spring-applied and hydraulic released.

Travel speed (low - high)

3.4 - 5.6 km/h

Maximum traction

37.9 t

Maximum gradeability

35° / 70%

WEIGHT

	Shoe width (mm)	Machine weight (t)	Ground pressure (kgf/cm²)
Triple grouser	600 (Std)	36.0	0.69
	700	36.5	0.60
	800	36.9	0.53
	850	37.1	0.50
	900	37.2	0.48
Double grouser	600	36.5	0.70

TECHNICAL SPECIFICATIONS

COMPONENT WEIGHTS

Item	Unit	Weight	Remarks
Upper structure without front	kg	16788	With counterweight
Lower structure assembly	kg	11833	
Counterweight	kg	7100	
Front assembly	kg	7331	Based on standard
Boom	mm kg	6500 / 6500 HD / 6520 two-piece 2760 / 2785 / 3062	Including bushing
Arm	mm kg	2600 / 3200 / 3200 HD / 3950 1170 / 1285 / 1365 / 1496	

BUCKETS

Bucket Type	Capacity (m³) SAE	Width (mm)		Weight (kg)	Standard track / narrow track					
		With side cutters	W/O side cutters		One-piece boom			Two-piece boom		
					Arm 2.60 m	Arm 3.20 m	Arm 3.95 m	Arm 2.60 m	Arm 3.20 m	Arm 3.95 m
GP	1.25	1278	1228	1302	A / A	A / A	A / A	- / A	- / A	- / B
	1.49	1460	1410	1408	A / A	A / B	B / C	- / A	- / B	- / C
	1.61	1550	1500	1472	A / A	A / B	B / C	- / A	- / B	- / D
	1.83	1718	1668	1597	A / B	B / C	C / D	- / B	- / C	- / D
HD	1.44	1272	1238	1389.4	A / A	A / A	B / C	- / A	- / B	- / C
	1.66	1428	1394	1489.3	A / B	A / C	C / D	- / B	- / C	- / D
	1.81	1588	1500	1588	A / B	B / C	C / D	- / C	- / C	- / D
	2.03	1684	1650	1684.1	B / C	C / D	D / -	- / C	- / D	- / -
	2.32	1892	1858	1817	C / D	D / -	- / -	- / D	- / -	- / -
Rock	1.28	1382	-	1474	A / A	A / A	A / B	- / A	- / A	- / B

A: Suitable for materials with a density less than or equal to 2100 kg/m³

B: Suitable for materials with a density less than or equal to 1800 kg/m³

C: Suitable for materials with a density less than or equal to 1500 kg/m³

D: Suitable for materials with a density less than or equal to 1200 kg/m³

Based on ISO 10567 and SAE J296, arm length without quick-coupler. For reference only.

DEVELON BUCKETS

4 More. More choice - More durable - More strength - More performance!

General Construction Bucket



The General purpose bucket is designed for digging and re-handling soft to medium materials (e.g. materials with low wear characteristics such as top-soil, loam, coal).

Heavy Construction Bucket



The Heavy duty bucket is designed for mass excavations in dense materials such as hard packed clay, shot limestone, limited rock content and gravel.

Severe Mining Bucket



The Severe duty bucket is designed for durability in digging compact materials like loose or blasted rock, hard packed clay and stone.

X-treme Mining Bucket



The X-treme duty bucket is designed as a long-life version of the Severe duty bucket for digging in the most abrasive materials.

DIMENSIONS

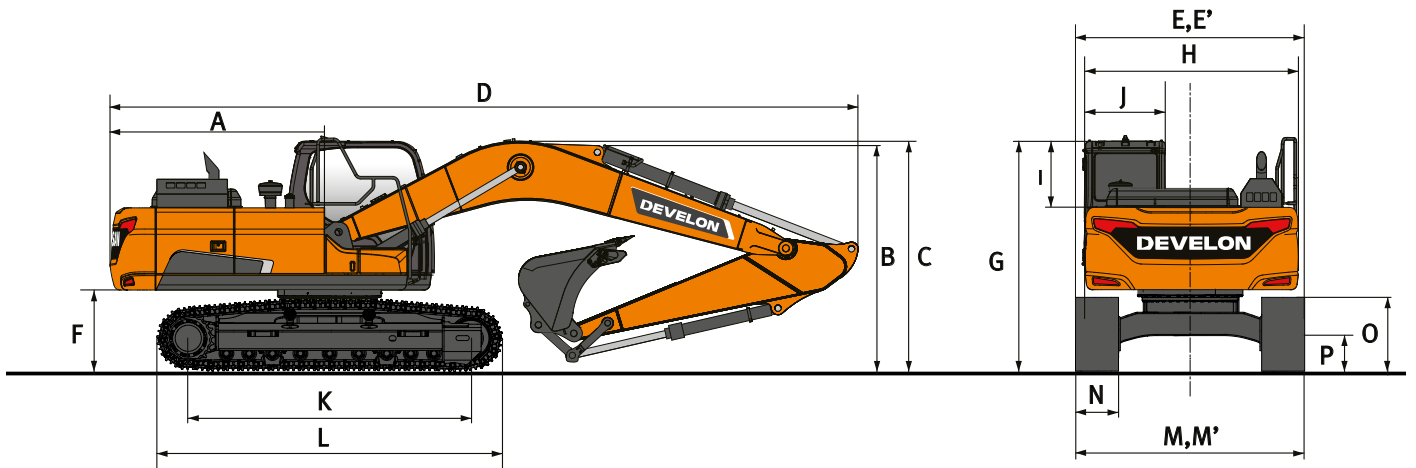

DIMENSIONS

	Unit	One-piece boom			Two-piece boom		
		6500			3435 LB + 3100 UB		
Boom length	mm						
Arm length	mm	2600	3200	3950	2600	3200	3950
Bucket capacity	m³	1.83	1.49	1.25	1.83	1.49	1.25
A Tail swing radius	mm	3530	3530	3530	3530	3530	3530
B Shipping height (boom)	mm	3495	3255	3420	3465	3505	3860
C Shipping height (hose)	mm	3640	3390	3550	3515	3555	3910
D Shipping length	mm	11405	11315	11345	11345	11350	11280
E Shipping width std.	mm	3280	3280	3280	3280	3280	3280
E' Shipping width narrow	mm	3000	3000	3000	3000	3000	3000
F Counterweight clearance	mm	1170	1170	1170	1170	1170	1170
G Height over cab	mm	3100	3100	3100	3100	3100	3100
H House width	mm	3000	3000	3000	3000	3000	3000
I Cab height above house	mm	853	853	853	853	853	853
J Cab width	mm	1010	1010	1010	1010	1010	1010
K Tumbler distance	mm	4040	4040	4040	4040	4040	4040
L Track length	mm	4940	4940	4940	4940	4940	4940
M Undercarriage width std	mm	3280	3280	3280	3280	3280	3280
M' Undercarriage width narrow	mm	3000	3000	3000	3000	3000	3000
N Shoe width std.	mm	600	600	600	600	600	600
O Track height	mm	970	970	970	970	970	970
P Ground clearance	mm	480	480	480	480	480	480

WORKING RANGE

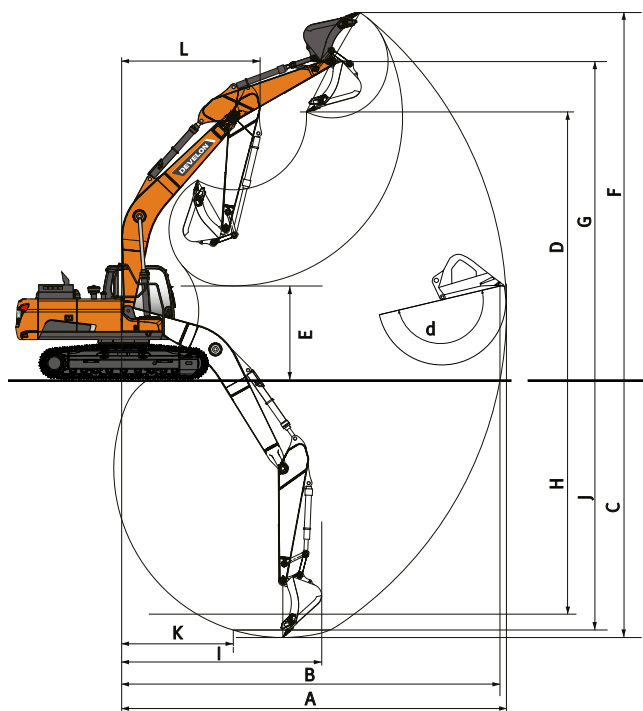

WORKING RANGE

	Unit	One-piece boom			Two-piece boom		
Boom length	mm	6500			3435 LB + 3100 UB		
Arm length	mm	2600	3200	3950	2600	3200	3950
Bucket capacity	m³	1.83	1.49	1.25	1.83	1.49	1.25
A Max. digging reach	mm	10600	11180	11940	10785	11390	12165
B Max. digging reach (ground)	mm	10390	10980	11755	10575	11195	11980
C Max. digging depth	mm	6940	7540	8295	6740	7355	8125
D Max. loading height	mm	6860	7170	7630	8535	9060	9750
E Min. loading height	mm	3305	2700	1945	4380	3635	2900
F Max. digging height	mm	9980	10325	10825	11940	12475	13175
G Max. bucket pin height	mm	8575	8885	9345	10250	10775	11465
H Max. vertical wall depth	mm	5100	5900	6840	5260	5945	6750
I Max. radius vertical	mm	7715	7720	7785	7510	7550	7680
J Max. digging depth (8' level)	mm	6720	7355	8155	6540	7255	8035
K Min. radius 8' level	mm	3270	3315	3385	1995	1995	1995
L Min. swing radius	mm	4480	4455	4515	3635	3440	3620
d Bucket angle	°	178	178	178	178	178	178

DIGGING FORCES (ISO)

	Unit	One-piece boom			Two-piece boom		
Boom length	mm	6500			3435 LB + 3100 UB		
Arm length	mm	2600	3200	3950	2600	3200	3950
Bucket capacity	m³	1.83	1.49	1.25	1.83	1.49	1.25
BUCKET (Normal/Press. Up)	ton	24.4 / 25.9	24.4 / 25.9	24.4 / 25.9	24.4 / 25.9	24.4 / 25.9	24.4 / 25.9
ARM (Normal/Press. Up)	ton	22.0 / 23.3	17.9 / 18.9	15.1 / 16.0	22.0 / 23.3	17.9 / 18.9	15.1 / 16.0

LIFTING CAPACITIES

STANDARD TRACK WIDTH: 3280 MM • W/O BUCKET

(UNIT: 1000 KG)

A	1.5 m		3.0 m		4.5 m		6.0 m		7.5 m		9.0 m		Max. reach		

One-piece boom 6.5 m • Arm 2.6 m • Shoe 600 mm • Counterweight 7.1 t

7.5 m														9.00 *	8.73	7.00
6.0 m							9.64 *	9.64 *	8.93 *	7.73				8.88 *	6.99	7.96
4.5 m					14.10 *	14.10 *	10.93 *	10.54	9.45 *	7.52				8.93 *	6.11	8.55
3.0 m							12.45 *	9.95	10.18 *	7.24				8.44	5.66	8.84
1.5 m							13.66 *	9.49	10.58	6.98				8.27	5.52	8.86
0.0 m					19.22 *	13.98	14.18 *	9.24	10.40	6.82				8.52	5.65	8.63
-1.5 m					18.31 *	14.03	13.93 *	9.18	10.36	6.78				9.29	6.13	8.11
-3.0 m			21.24 *	21.24 *	16.48 *	14.25	12.71 *	9.30						10.05 *	7.24	7.24
-4.5 m			16.60 *	16.60 *	13.07 *	13.07 *								9.84 *	9.84 *	5.87

One-piece boom 6.5 m • Arm 3.2 m • Shoe 600 mm • Counterweight 7.1 t

7.5 m									8.06 *	7.93				8.04 *	7.50	7.74
6.0 m									8.19 *	7.84				7.84 *	6.20	8.61
4.5 m					12.59 *	12.59 *	10.09 *	10.09 *	8.82 *	7.59	8.19 *	5.65		7.92 *	5.49	9.15
3.0 m					16.02 *	15.34	11.71 *	10.09	9.66 *	7.28	8.22	5.51		7.65	5.12	9.42
1.5 m					18.45 *	14.34	13.12 *	9.55	10.45 *	6.98	8.06	5.36		7.50	4.99	9.45
0.0 m					19.22 *	13.93	13.94 *	9.21	10.36	6.77	7.95	5.26		7.67	5.08	9.23
-1.5 m			15.04 *	15.04 *	18.80 *	13.86	14.01 *	9.08	10.25	6.68				8.26	5.45	8.74
-3.0 m	17.88 *	17.88 *	23.46 *	23.46 *	17.41 *	14.01	13.23 *	9.12	10.22 *	6.73				9.36 *	6.25	7.95
-4.5 m			19.57 *	19.57 *	14.70 *	14.36	11.12 *	9.38						9.42 *	8.05	6.73

One-piece boom 6.5 m • Arm 3.95 m • Shoe 600 mm • Counterweight 7.1 t

9.0 m									7.01 *	7.01 *				6.80 *	6.80 *	7.55
7.5 m														6.31 *	6.21	8.71
6.0 m									7.28 *	7.28 *	7.18 *	5.84		6.12 *	5.29	9.49
4.5 m							8.94 *	8.94 *	7.99 *	7.70	7.46 *	5.72		6.11 *	4.76	9.98
3.0 m					14.12 *	14.12 *	10.65 *	10.27	8.93 *	7.35	7.94 *	5.53		6.28 *	4.47	10.23
1.5 m					17.12 *	14.60	12.29 *	9.64	9.86 *	6.99	8.04	5.34		6.58	4.36	10.26
0.0 m					18.70 *	13.91	13.43 *	9.19	10.31	6.72	7.88	5.18		6.70	4.41	10.05
-1.5 m	9.11 *	9.11 *	13.22 *	13.22 *	18.95 *	13.66	13.88 *	8.95	10.13	6.56	7.79	5.10		7.11	4.67	9.61
-3.0 m	14.30 *	14.30 *	19.31 *	19.31 *	18.14 *	13.68	13.56 *	8.91	10.10	6.53				7.96	5.22	8.90
-4.5 m	20.56 *	20.56 *	22.58 *	22.58 *	16.18 *	13.93	12.22 *	9.05	9.20 *	6.68				8.47 *	6.34	7.83
-6.0 m			16.79 *	16.79 *	12.38 *	12.38 *	8.83 *	8.83 *						8.21 *	8.21 *	6.23

Two-piece boom • Arm 2.6 m • Shoe 600 mm • Counterweight 7.1 t

9.0 m					13.71 *	13.71 *								12.45 *	12.24	5.78
7.5 m					13.75 *	13.75 *	11.75 *	11.64						10.72 *	8.45	7.24
6.0 m					15.08 *	15.08 *	12.22 *	11.34	10.31 *	7.94				9.61 *	6.86	8.17
4.5 m							13.13 *	10.81	10.76 *	7.72				8.97	6.05	8.74
3.0 m							13.98 *	10.22	11.15 *	7.44	8.45	5.67		8.41	5.65	9.02
1.5 m							14.24 *	9.76	10.88	7.19	8.34	5.57		8.28	5.53	9.05
0.0 m							13.61 *	9.53	10.68 *	7.04				8.30 *	5.69	8.82
-1.5 m					14.63 *	14.55	12.01 *	9.50	9.32 *	7.03				7.57 *	6.18	8.31
-3.0 m					11.00 *	11.00 *	9.22 *	9.22 *						6.26 *	6.26 *	7.46

Two-piece boom • Arm 3.2 m • Shoe 600 mm • Counterweight 7.1 t

10.5 m					10.71 *	10.71 *								10.14 *	10.14 *	4.61
9.0 m							10.77 *	10.77 *						8.08 *	8.08 *	6.71
7.5 m							10.95 *	10.95 *	9.59 *	8.15				7.30 *	7.25	7.99
6.0 m					11.75 *	11.75 *	11.52 *	11.52 *	9.68 *	8.05				6.97 *	6.07	8.84
4.5 m					16.20 *	16.20 *	12.51 *	10.99	10.19 *	7.80	8.30 *	5.81		6.90 *	5.42	9.37
3.0 m					18.50 *	15.73	13.55 *	10.35	10.88 *	7.48	8.46	5.68		7.04 *	5.09	9.63
1.5 m					19.21 *	14.74	14.12 *	9.82	10.89	7.18	8.31	5.53		7.40 *	4.99	9.66
0.0 m					18.27 *	14.37	13.86 *	9.50	10.67	6.98	8.21	5.44		7.68	5.11	9.44
-1.5 m			13.08 *	13.08 *	16.10 *	14.36	12.68 *	9.39	9.90 *	6.91				7.13 *	5.48	8.97
-3.0 m					12.86 *	12.86 *	10.41 *	9.47	7.82 *	7.00				6.15 *	6.15 *	8.20















Two-piece boom • Arm 3.95 m • Shoe 600 mm • Counterweight 7.1 t

10.5 m							8.20 *	8.20 *						7.51 *	7.51 *	6.15
9.0 m							9.05 *	9.05 *	7.81 *	7.81 *				6.28 *	6.28 *	7.83
7.5 m							8.56 *	8.56 *	8.80 *	8.36				5.71 *	5.71 *	8.95
6.0 m							8.83 *	8.83 *	8.99 *	8.21	7.62 *	6.01		5.43 *	5.19	9.71
4.5 m					11.00 *	11.00 *	10.99 *	10.99 *	9.49 *	7.91	7.77 *	5.88		5.34 *	4.71	10.19
3.0 m					17.25 *	16.26	12.84 *	10.54	10.26 *	7.55	8.08 *	5.69		5.38 *	4.45	10.44
1.5 m					18.89 *	14.99	13.73 *	9.90	10.85 *	7.19	8.28	5.50		5.57 *	4.37	10.46
0.0 m					18.84 *	14.32	13.91 *	9.46	10.62	6.92	8.12	5.35		5.92 *	4.45	10.26
-1.5 m			11.47 *	11.47 *	17.37 *	14.12	13.21 *	9.25	10.32 *	6.78	8.03 *	5.29		6.43 *	4.72	9.83
-3.0 m			17.63 *	17.63 *	14.73 *	14.20	11.53 *	9.24	8.92 *	6.78	6.11 *	5.37		5.67 *	5.29	9.13
-4.5 m					10.76 *	10.76 *	8.56 *	8.56 *	6.01 *	6.01 *				4.72 *	4.72 *	8.00

LIFTING CAPACITIES

NARROW TRACK WIDTH: 3000 MM • W/O BUCKET

(UNIT: 1000 KG)

A	1.5 m		3.0 m		4.5 m		6.0 m		7.5 m		9.0 m		Max. reach	
														

One-piece boom 6.5 m • Arm 2.6 m • Shoe 600 mm • Counterweight 7.1 t

7.5 m														9.00 *	7.85	7.00
6.0 m								9.64 *	9.64 *	8.93 *	6.94			8.88 *	6.27	7.96
4.5 m					14.10 *	14.10 *		10.93 *	9.41	9.45 *	6.73			8.93 *	5.46	8.55
3.0 m								12.45 *	8.85	10.18 *	6.46			8.42	5.05	8.84
1.5 m								13.66 *	8.40	10.55	6.21			8.25	4.91	8.86
0.0 m					19.22 *	12.18		14.18 *	8.15	10.37	6.05			8.49	5.02	8.63
-1.5 m					18.31 *	12.23		13.93 *	8.09	10.33	6.01			9.26	5.45	8.11
-3.0 m			21.24 *	21.24 *	16.48 *	12.43		12.71 *	8.21					10.05 *	6.43	7.24
-4.5 m			16.60 *	16.60 *	13.07 *	12.86								9.84 *	8.84	5.87

One-piece boom 6.5 m • Arm 3.2 m • Shoe 600 mm • Counterweight 7.1 t

7.5 m										8.06 *	7.13			8.04 *	6.74	7.74
6.0 m										8.19 *	7.05			7.84 *	5.55	8.61
4.5 m					12.59 *	12.59 *		10.09 *	9.58	8.82 *	6.80	8.19 *	5.05	7.92 *	4.91	9.15
3.0 m					16.02 *	13.47		11.71 *	8.97	9.66 *	6.50	8.20	4.91	7.62	4.56	9.42
1.5 m					18.45 *	12.52		13.12 *	8.45	10.45 *	6.21	8.04	4.77	7.47	4.43	9.45
0.0 m					19.22 *	12.13		13.94 *	8.12	10.32	6.00	7.93	4.67	7.65	4.51	9.23
-1.5 m			15.04 *	15.04 *	18.80 *	12.06		14.01 *	7.99	10.22	5.91			8.23	4.83	8.74
-3.0 m	17.88 *	17.88 *	23.46 *	23.46 *	17.41 *	12.20		13.23 *	8.04	10.22 *	5.96			9.36 *	5.55	7.95
-4.5 m			19.57 *	19.57 *	14.70 *	12.54		11.12 *	8.28					9.42 *	7.13	6.73



Two-piece boom • Arm 2.6 m • Shoe 600 mm • Counterweight 7.1 t

9.0 m					13.71 *	13.71 *								12.45 *	11.07	5.78
7.5 m					13.75 *	13.75 *		11.75 *	10.54					10.72 *	7.66	7.24
6.0 m					15.08 *	15.08 *		12.22 *	10.26	10.31 *	7.19			9.61 *	6.21	8.17
4.5 m								13.13 *	9.74	10.76 *	6.98			9.00	5.46	8.74
3.0 m								13.98 *	9.16	11.15 *	6.70	8.48	5.11	8.44	5.09	9.02
1.5 m								14.24 *	8.72	10.92	6.46	8.37	5.01	8.31	4.98	9.05
0.0 m								13.61 *	8.50	10.68 *	6.31			8.30 *	5.11	8.82
-1.5 m					14.63 *	12.81		12.01 *	8.47	9.32 *	6.30			7.57 *	5.56	8.31
-3.0 m					11.00 *	11.00 *		9.22 *	8.63					6.26 *	6.26 *	7.46

Two-piece boom • Arm 3.2 m • Shoe 600 mm • Counterweight 7.1 t

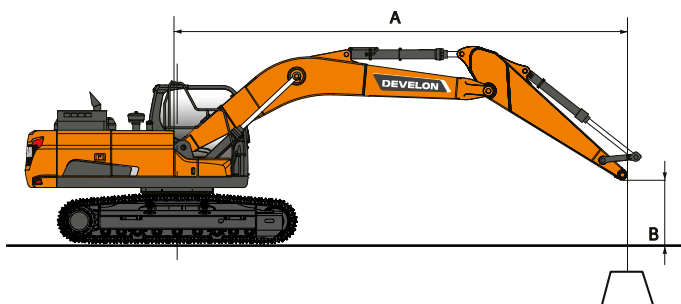
10.5 m					10.71 *	10.71 *								10.14 *	10.14 *	4.61
9.0 m								10.77 *	10.73					8.08 *	8.08 *	6.71
7.5 m								10.95 *	10.75	9.59 *	7.39			7.30 *	6.57	7.99
6.0 m					11.75 *	11.75 *		11.52 *	10.44	9.68 *	7.30			6.97 *	5.48	8.84
4.5 m					16.20 *	15.32		12.51 *	9.91	10.19 *	7.05	8.30 *	5.25	6.90 *	4.89	9.37
3.0 m					18.50 *	13.93		13.55 *	9.29	10.88 *	6.74	8.49	5.11	7.04 *	4.58	9.63
1.5 m					19.21 *	12.99		14.12 *	8.77	10.93	6.45	8.34	4.97	7.40 *	4.48	9.66
0.0 m					18.27 *	12.64		13.86 *	8.46	10.71	6.25	8.24	4.88	7.71 *	4.58	9.44
-1.5 m			13.08 *	13.08 *	16.10 *	12.62		12.68 *	8.36	9.90 *	6.18			7.13 *	4.92	8.97
-3.0 m					12.86 *	12.81		10.41 *	8.44	7.82 *	6.27			6.15 *	5.64	8.20



 : Rating over front.
 : Rating over side or 360°.

- Lifting capacities are in compliance with ISO 10567:2007(E).
- The load point is at the end of the arm.
- * = The nominal loads are based on hydraulic capacity.
- The nominal loads shown do not exceed 75% of tipping loads or 87% of hydraulic lifting capacity.
- For lifting capacity with bucket, simply subtract the actual weight of the bucket from the values.
- The configurations indicated do not necessarily reflect the standard equipment of the machine.

STANDARD AND OPTIONAL EQUIPMENT

● Standard ○ Optional

Engine

- Develon, Stage V compliant, SCR, DOC and DPF post treatment
- Variable Turbo Charger and air-to-air intercooler
- Auto-idle function
- Auto shut-off

Hydraulic system

- Boom and arm flow regeneration
- Swing anti-rebound valves
- Spare ports (valve)
- Flow and pressure adjustment of hydraulics lines controlled from the cab
- One-touch power boost function
- Smart Power Control (SPC)
- Breaker piping
- Cylinder cushioning & contamination seals
- Setting of auxiliary hydraulic flow and pressure from the display panel

Cab & Interior

- Pressurised, sound-insulated and CabSus mounted cab
- Heated, adjustable air suspension seat with adjustable headrest and armrests
- Air conditioning with climate control
- Pull-up type front window with sun roller blind and removable lower front window
- Sliding left window
- Intermittent upper and lower windshield parallel wiper
- Rain visor
- Rear window defroster switch
- Adjustable PPC wrist control levers for arm, boom, bucket and swing
- Joysticks and pedals provide proportional control of auxiliary lines for attachments
- Travel pedals with hand levers
- Jog shuttle switch
- DEVELON Smart Touch – 8" touch screen, all-in-one
- Attachment management system
- Engine speed (RPM) control dial
- Automatic travel speed
- 4 operating modes & 4 working modes
- Electric horn
- Ceiling light
- Cup holders
- Multiple storage compartments (e.g. document holder under seat)
- Storage area (tools, etc.)
- Heating and cooling lunch box
- Flat, spacious, easy-to-clean floor
- Keyless start (Develon Smart Key) & remote door lock/unlock
- Anti-theft protection
- 12 V power socket and USB ports
- Serial communication port for laptop PC interface
- Radio + MP3 (stereo) with Bluetooth streaming and handsfree call system
- Heated and cooled, adjustable air suspension seat with adjustable headrest and armrests

Safety

- Roll Over Protective Structure (ROPS)
- Boom and arm cylinder safety valves
- Overload warning device
- Large guard rails on upper structure and steps
- Rotating beacon
- 360° all-around view camera (AVM)

- Punched metal anti-slip plates
- Hydraulic safety lock lever
- Safety glass
- Hammer for emergency escape
- Right and left rear-view mirrors
- Lockable fuel cap and covers
- Battery cut-off switch
- Engine restart prevention system
- Parking brake
- LED lights pack: 9 powerful LED lights
- Emergency engine stop switch and hydraulic pump control switch
- FOGS cab - top and front cab guards (ISO 10262)
- Front window upper and lower guards
- Ultrasonic detection
- LED work lights: 4 additional lamps (2 in the front, 2 in the rear of the cab)

Other

- Boom: 6500 mm – arm: 3200 mm – counterweight: 7100 kg
- DEVELON Fleet Management Web (telematic system)
- Auto shut-off fuel filler pump
- Double element air cleaner and pre-filtered Cyclone Turbo dust separator
- Fuel pre-filter with water separator sensor
- Dust screen for radiator/oil cooler
- Hydraulically-driven oil cooler fan
- Self-diagnostic function
- Alternator (24 V, 80 A) - Battery (2 × 12 V, 150 Ah)
- Hydrostatic 2-speed travel system with automatic shift
- Remote greasing for swing circle and work group pivot points
- Electric transfer pump for initial priming of fuel filters
- Engine coolant heater
- Double pump flow
- Boom: 6500 mm heavy duty (with heavy duty 3200 mm arm)
- Arms: 2600 mm, 3200 mm heavy duty or 3950 mm
- Air compressor
- Side protector (For NLC version, the side protector will increase the transportation width by 12 cm, but is easily removable.)
- Booms: one piece boom 6500 mm with 7100 kg counterweight or two-piece boom (3435 mm LB + 3100 mm UB) with 7100 kg counterweight
- Develon buckets: full range of GP, HD & Rock buckets
- Develon quick-couplers
- Hydraulic piping for crusher, quick-coupler, tilting and rotating buckets
- Additional filter for breaker piping
- Floating boom
- Oil-washed air cleaner
- Straight travel pedal (not to be combined with two-piece boom)
- Automatic lubrication system
- Alarm for travel & swing

Undercarriage

- X-frame with hydraulic track adjuster
- Normal track guards
- Greased and sealed track links
- 600 mm triple grouser shoe
- Narrow undercarriage
- Double track guards
- Full-length track guards
- 600 mm double grouser shoe
- 700 mm, 800 mm, 850 mm, 900 mm triple grouser shoe

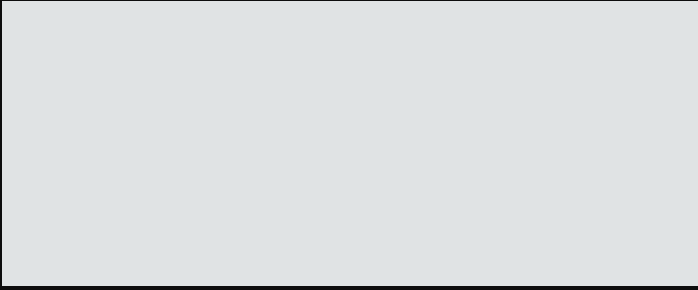

Powered by Innovation

DISCOVER MORE:
DX350LC-7K

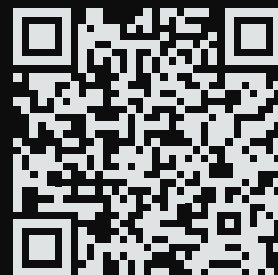

DEVELON

DOOSAN Infracore Europe s.r.o.
IBC - Pobřežní 620/3, 186 00 Praha 8-Karlín
Czech Republic

©2023 DEVELON D4600664-EN (05-23)

Certain specification(s) are based on engineering calculations and are not actual measurements. Specification(s) are provided for comparison purposes only and are subject to change without notice. Specification(s) for your individual Develon equipment will vary based on normal variations in design, manufacturing, operating conditions, and other factors. Pictures of Develon units may show other than standard equipment.